

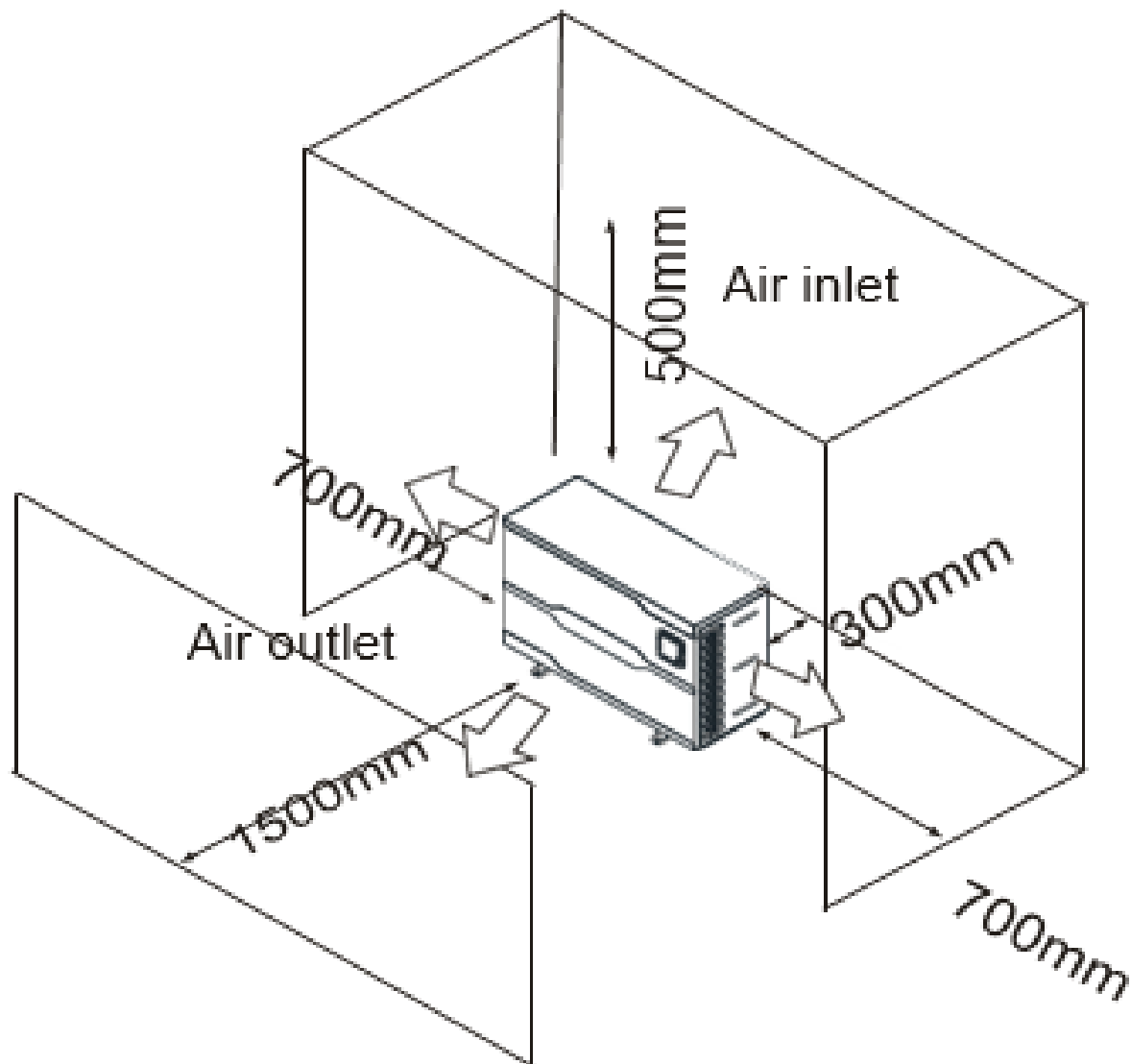

Monobloc	Type	PMXD12i			Type	Monobloc
	Fabriekscod	PASRW030-P-BP6II-X			Code de fabrication	
Koelmiddel		R32				Réfrigérant
Verwarming	Vermogen nom. A24/W26	kW	2,18~11,83	kW	Puissance nom. A24/W26	Chauffage
	Opgen. Elektr. Vermogen	kW	0,24~1,96	kW	Puissance él. absorbée	
	COP		4,79~8,1		COP	
	Vermogen nom. A15/W26	kW	1,6~9,1	kW	Puissance nom. A15/W26	
	Opgen. Elektr. Vermogen	kW	0,24~1,89	kW	Puissance él. absorbée	
	COP		4,8~6,7		COP	
	Vermogen A-7/W26	kW	-	kW	Puissance A-7/W26	
Koeling	Vermogen nom. A35/W24	kW	3,46	kW	Puissance nom. A35/W24	Refroidissement
	Opgen. Elektr. Vermogen	kW	1,22	kW	Puiss. absorb.nom	
	EER		2,84		EER	
Buitendeel	Waterdebiet nominaal	m³/u	4,1	m³/h	Débit d'eau nominal	Unité extérieure
	Drukverlies max.	kPa	4	kPa	Perte de pression maximum	
	Werkingslimieten verwarmen min/max	°C	-10/43	°C	Limites de fonct. chauffer min/max	
	Werkingslimieten koelen min/max	°C	15/43	°C	Limites de fonct. refroidir min/max	
	Zwembadtemp. min/max	°C	8/35	°C	Temp. piscine min/max	
	Omkastng		metaal/métal		Habillage	
	Lengte-breedte-hoogte	mm	1030x455x635	mm	Profondeur-largeur-hauteur	
	Geluidsdrukniveau (Silent Mode) op 1m	dB(A)	47 (41)	dB(A)	Niveau sonore press. (Mode Silente) à 1 m	
	Compressor		Inverter DC		Compresseur	
	Gewicht (netto)	kg	67	kg	Poids (net)	
Kleur (benadering)	RAL	9005	RAL	Couleur (approximative)		
Elektrische installatie	Voeding	V	230/1F	V	Alimentation	Installation électrique
	Stroom max	A	10,3	A	Courant max	
	Zekering traag	A	16	A	Fusible retardé	
	Sectie voedingskabel	mm²	3G2,5	mm²	Section câble d'alimentation	
Technische installatie	Hydr. aansluitdiameter	mm	50	mm	Diam. raccordement hydr.	Installation technique
	Koppelingen incl. lijm		PVC		Raccords inclu colle	
	Regeleenheid		LCD Z/W - N/B		Unité de réglage	
	Expansieventiel		EEV		Vanne de détente	
	Ontdooiacyclus		incl.		Cycle de dégivrage	
Inclusief	afdekzeil		incl.		couverture	Inclusive
	Wifi-module		incl.		Wifi-module	
	koppelingen voor wateraansluiting		incl.		raccordements d'eau	
Koelmiddel (*)	Koudemiddel		R32		Réfrigérant	Réfrigérant (*)
	GWP-waarde		675		GWP-valeur	
	Standaardvulling	kg-m	0,5	kg-m	Charge standard	
	CO ₂ eq. Standaardvulling	ton	0,338	ton	CO ₂ eq. Charge standard	
	Bijvulling	g/m	-	g/m	Charge supplémentaire	
	CO ₂ eq. Bijvulling	ton/m	-	ton/m	CO ₂ -eq Charge supplémentaire	
	Bevat gefluoreerde broeikasgassen		Ja/Oui		Contient des gaz à effet de serre fluorés	
	Hermetisch gesloten koelcircuit		Ja/Oui		hermétiquement scellé	

(*) Europese verordening nr 517/2014 betreffende gefluoreerde broeikasgassen

(*) Le décret Européen n° 517/2014 sur le gaz à effet de serre fluorés

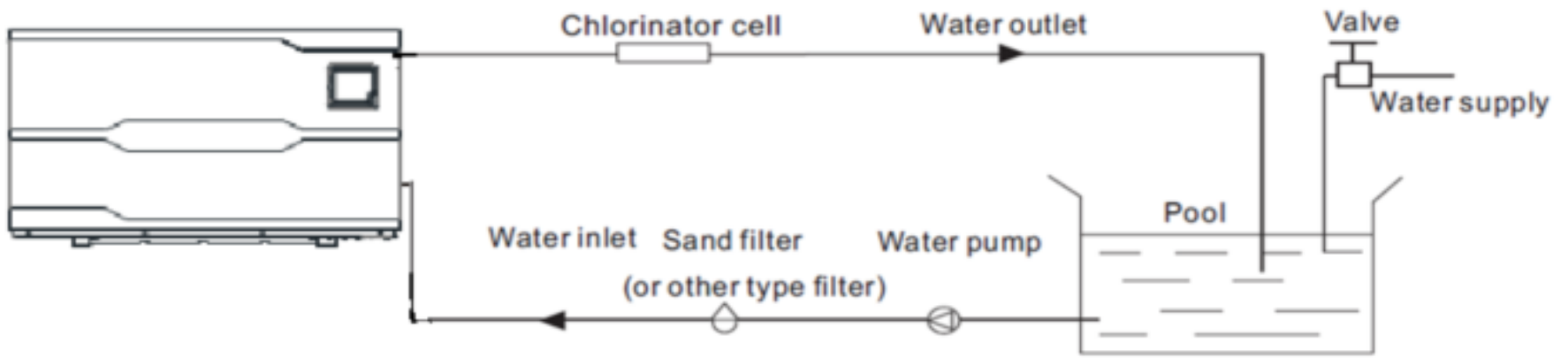

Poolstage

Poolstage





Poolstage

PMXD12i

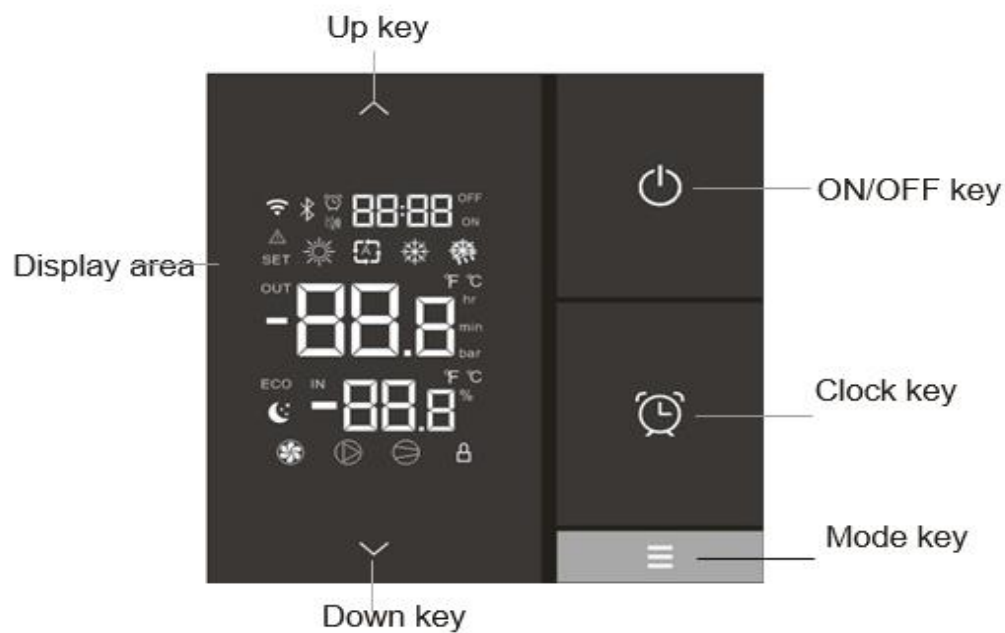
Bediening

Commande



Key symbols	Designation	Function
	On-off key	It is used to carry out startup & shutdown, cancel current operation, and return to the last level of operation.
	Clock key	It is used as user clock, and to carry out timing setting.
	Mode key	It is used to switch the unit mode, temperature setting, and parameter setting.
	Up key	It is used to page up, and increase variable value.
	Down key	It is used to page down, and decrease variable value.

Poolstage

PMXD12i

Circulatiepomp aansluiten

Connecter pompe de circulation

