

AircoHeater



Binnenunit	Type	AU12RIX			Type	Unité intérieure
	Fabriekscode	AUXG12KVLA			Code de fabrication	
Koelmiddel		R32				Réfrigérant
Verwarming (*)	Vermogen	kW	4,42	kW	Puissance	Chauffage (*)
Koeling (*)	Vermogen	kW	3,66	kW	Puissance	Refroid. (*)
Binnendeel	Debiet Q/L/M/H	m³/h	410/470/530/610	m³/h	Débit Q/L/M/H	Unité intérieure
	Geluidsdruk Q/L/M/H (1m)	dB(A)	28/31/34/37	dB(A)	Niv. son. press. Q/L/M/H (1m)	
	Werkingslim. verwarmen	°C	16~30	°C	Plage de fonct. chauff.	
	Werkingslim. koelen	°C	18~30	°C	Plage de fonct. refroid.	
	Hoogte-breedte-lengte	mm	245-570-570	mm	Hauteur/largeur/profond.	
	Inbouwhoogte	mm	262	mm	Hauteur encastrable	
	Gewicht	kg	10	kg	Poids	
Tech.install.	Expansie		Ext.		Détente	Install. Techn.
	Koelleidingen	inch	3/8 -1/4	inch	Lignes frigorifique	
	Sectie tssn bi en bu	mm²	4G1.5	mm²	Section entre int. et ext.	
	Diam. condensafvoer	mm	25/32	mm	Diam. évac. Condensat	

(*) gegevens volgens de norm EN14511

(*) SCOP & SEER based on (EU)626/2011

(*) suivant la norme EN14511

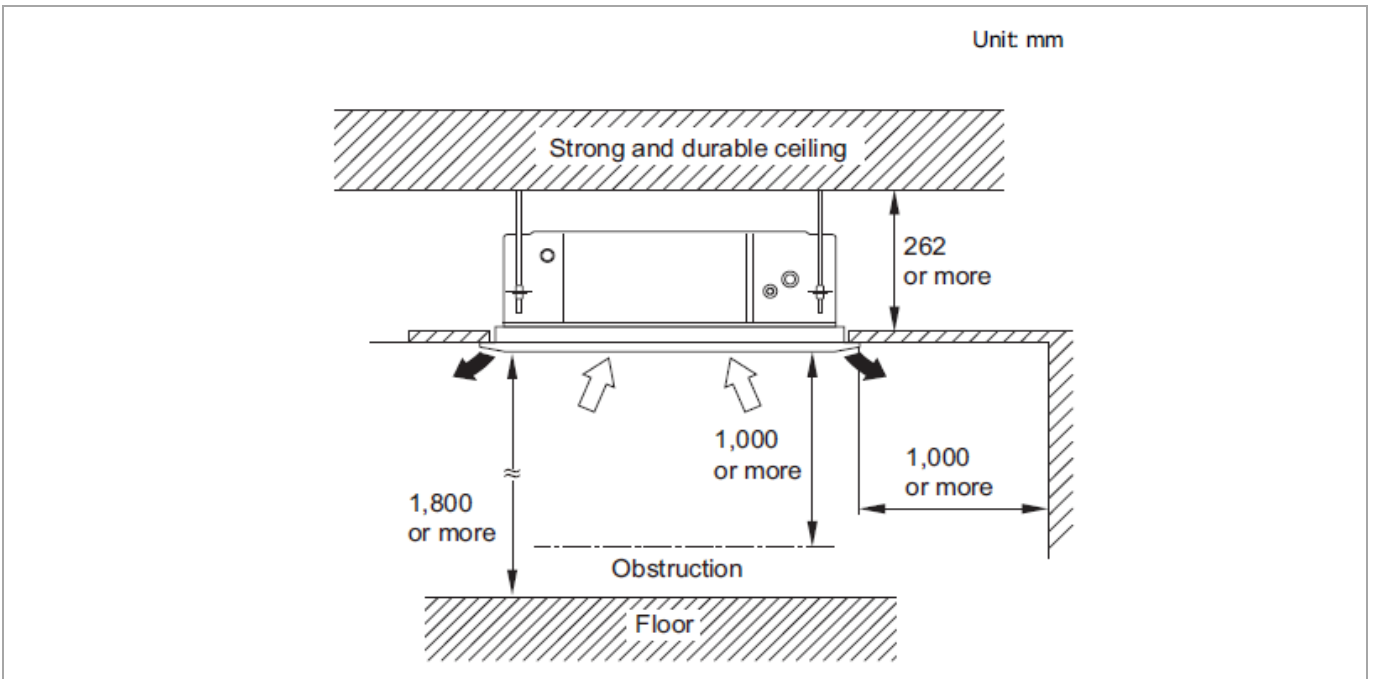
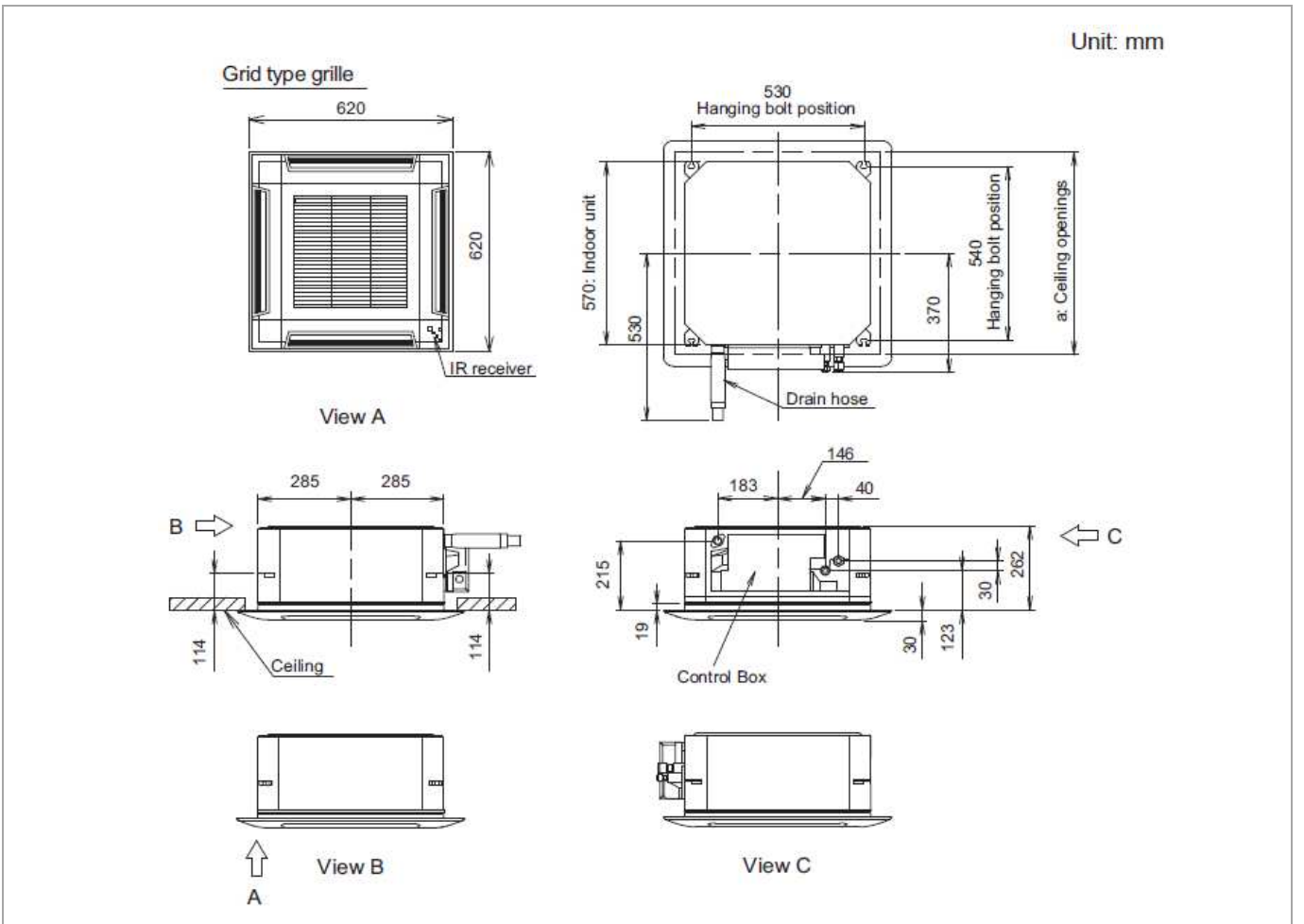

Maximum height from floor to ceiling (Unit: mm)		
	07 and 09 models	12 and 14 models
Standard	2,700	
High ceiling	—	3,000