





SCOP 		SEER 			
Binnenunit	Type	AR45RIX		Type	
	Fabriekscode	ARXG45KMLA		Fabriekscode	
Buitenunit	Type	AON45RIX		Type	
	Fabriekscode	AOHG45KATA		Fabriekscode	
Koelmiddel		R32			Réfrigérant
Verwarming (*)	Vermogen (+7°C)	kW	13,5 (4,2~15,0)	kW	Puissance (+7°C)
	Electr.verm. (+7°C)	kW	4,18	kW	Puiss. absorb.nom (+7°C)
	COP (+7°C) / SCOP(*)		3,23/n.v.t.		COP (+7°C) / SCOP(*)
	verm. max. bij -5°/-10°/-15°C	kW	12,50/11,37/10,24	kW	puiss. max. à -5°/-10°/-15°C
Koeling (*)	Vermogen	kW	12,1 (4,0~12,6)	kW	Puissance
	Electr.verm.	kW	4,84	kW	Puiss. absorb.nom
	EER / SEER (*)		2,50/n.v.t.		EER / SEER (*)
Pdesign	Verw. (Av.)(-10°C) / koelen	kW	n.v.t.	kW	Chauff. (Av.)(-10°C) / refroid.
Jaarverbruik	Verw. (Av.) / koelen	kWh/jaar	n.v.t.	kWh/aan	Chauff. (Av.) / refroid.
Binnendeel	Debiet Q/L/M/H	m³/h	1070/1350/1750/2100	m³/h	Débit Q/L/M/H
	Geluidsdruk Q/L/M/H (1m)	dB(A)	28/32/38/42	dB(A)	Niv. son. press. Q/L/M/H (1m)
	Werkgebied ext. stat. druk	Pa	30-150	Pa	Plage de fonct. Press. stat. ext.
	Ext. stat. druk fabreksinst.	Pa	60	Pa	Réglage d'usine press. stat. ext.
	Werkingslim. verwarmen	°C	16~30	°C	Plage de fonct. chauff.
	Werkingslim. koelen	°C	18~32	°C	Plage de fonct. refroid.
	Hoogte-breedte-lengte	mm	270-1135-700	mm	Hauteur/largeur/profond.
	Gewicht	kg	39	kg	Poids
Buitendeel	Geluidsdruk (1m)	dB(A)	58	dB(A)	Niv. son. press. (1m)
	Geluidsvermogen	dB(A)	72	dB(A)	Niv. son. puiss.
	Debiet	m³/h	4450	m³/h	Débit
	Compressor		DC Twin rotary		Compresseur
	Werkingslim. verwarmen	°C	-15~24	°C	Plage de fonct. chauff.
	Werkingslim. koelen	°C	-15~46	°C	Plage de fonct. refroid..
	Hoogte-breedte-lengte	mm	998-940-320	mm	Hauteur/largeur/profond.
Gewicht	kg	61	kg	Poids	
Elektr.install.	Voeding	V	230/1F	V	Alimentation
	Stroom max. verw./koel.	A	28,1-28,1	A	Amp. max chauff. / refroid.
	Zekering traag	A	32	A	Fusible retardé
	Hoofdvoeding aanbr.op		Buiten		Unité à alimenter
	Sectie voedingskabel	mm²	3G6	mm²	Section câble alimentation
Sectie tssn bi en bu	mm²	4G1,5	mm²	Section entre int. et ext.	
Tech.install.	Expansie		Ext.		Détente
	Koelleidingen	inch	5/8-3/8	inch	Lignes frigorifique
	Leidinglengte min-max	m	5-30	m	Longueur min / max
	Hoogteverschil max	m	30	m	Dénivelé max
Diam. condensafvoer bi/bu	mm	36/38	mm	Diam. évac. condensat int/ext	
Koelmiddel (**)	Koudemiddel		R32		Réfrigérant
	GWP-waarde		675		Valeur GWP
	Standaardvulling-afstand	kg-m	2,4-30	kg-m	Charge standard-distance
	CO ₂ eq. Standaardvulling	kg	1620	kg	CO ₂ eq. Charge standard
	Bijvulling extra	g/m	-	g/m	Charge supplémentaire
	CO ₂ eq. Bijvulling	kg/m	-	kg/m	CO ₂ -eq Charge supplémentaire
	Bevat gefluoreerde broeikasgassen		Ja/Oui		Contient des gaz à effet de serre fluorés
	Hermetisch gesloten koelcircuit		Nee/Non		hermétiquement scellé

(*) gegevens volgens de norm EN14511

(*) SCOP & SEER based on (EU)626/2011

(*) suivant la norme EN14511

(**) Europese verordening nr 517/2014 betreffende gefluoreerde broeikasgassen

(**)Le décret Européen n°517/2014 sur le gaz à effet de serre fluorés

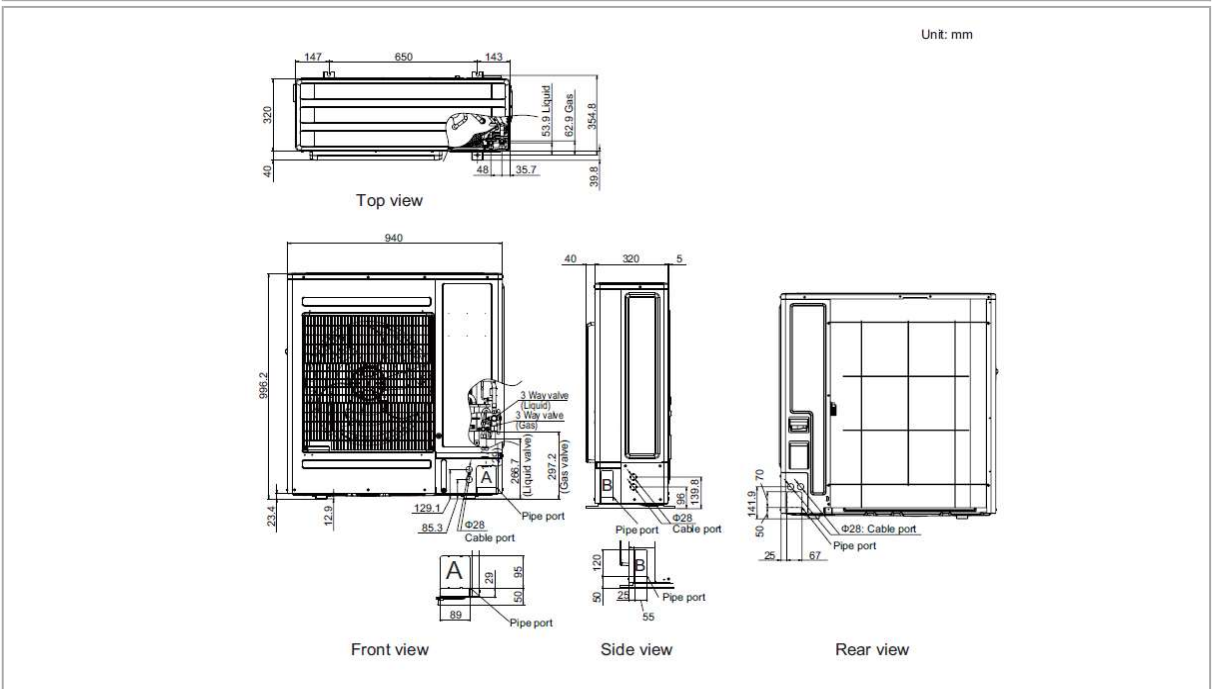
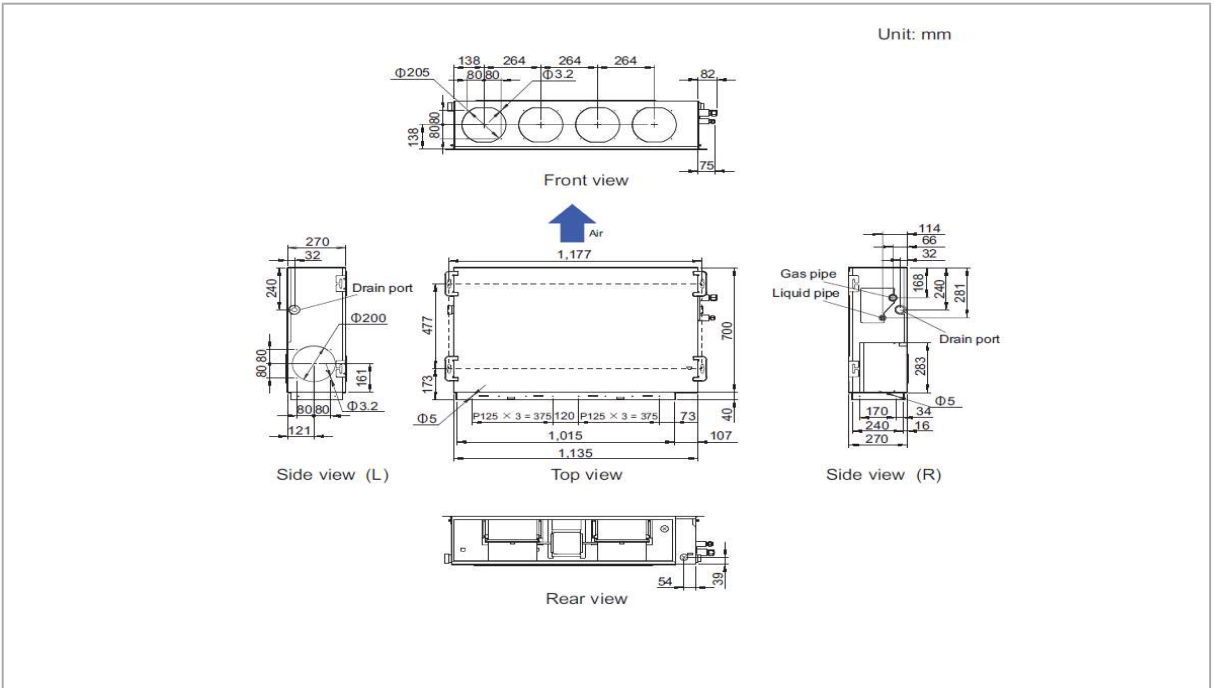

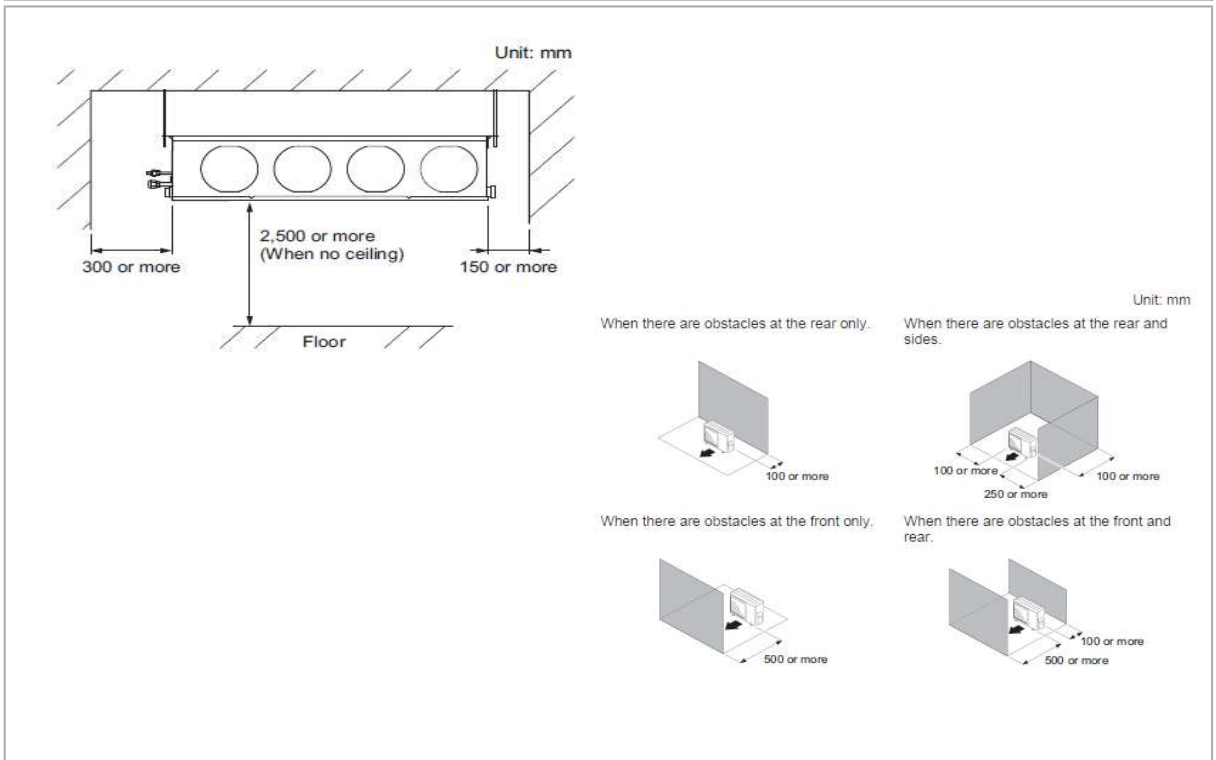
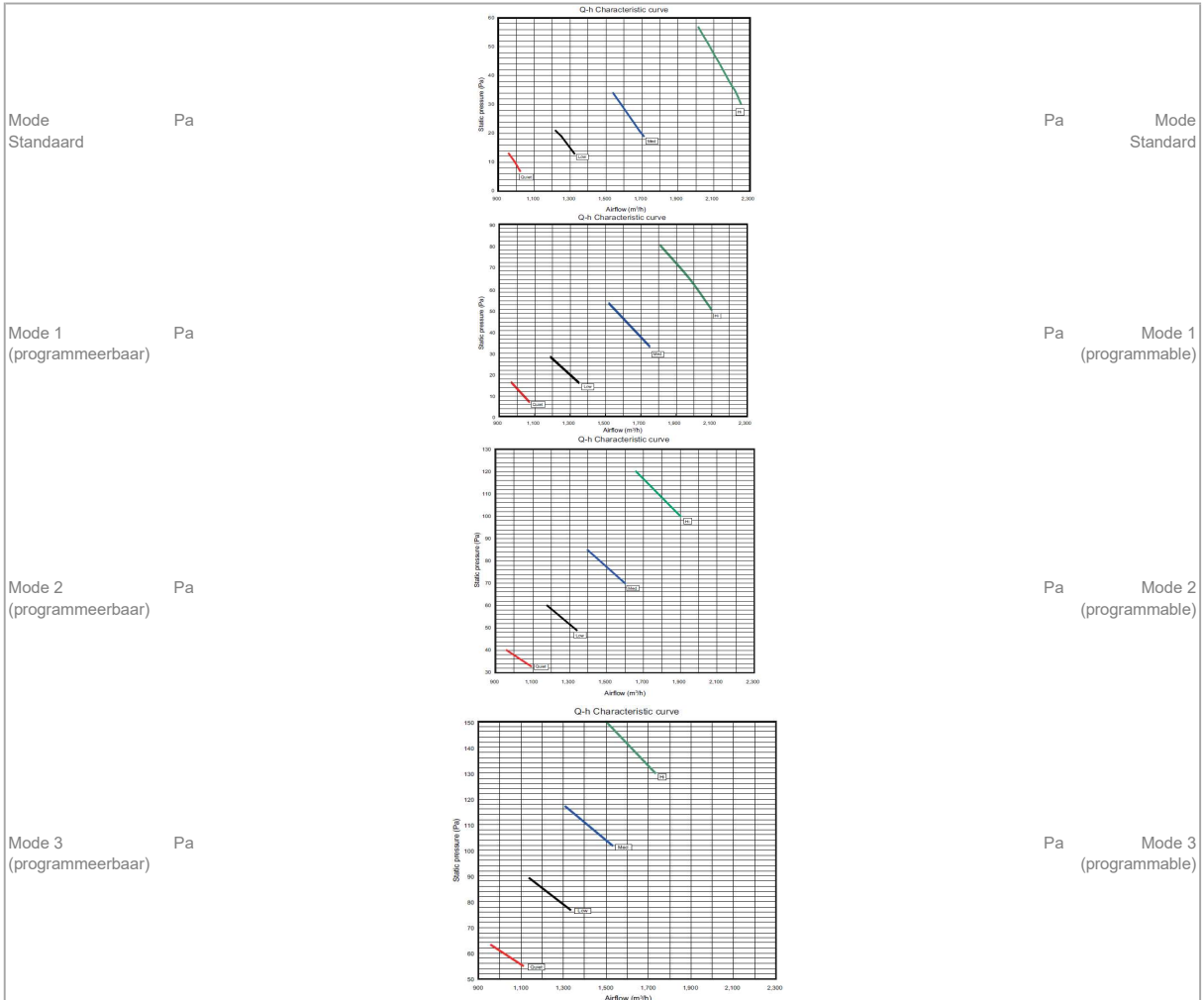

UTY-RNRGZ3



UTY-RLRG



UTY-RSRG



UTY-RVNGM



UTY-RNNGM



UTY-RSNGM



UTY-LBTGM



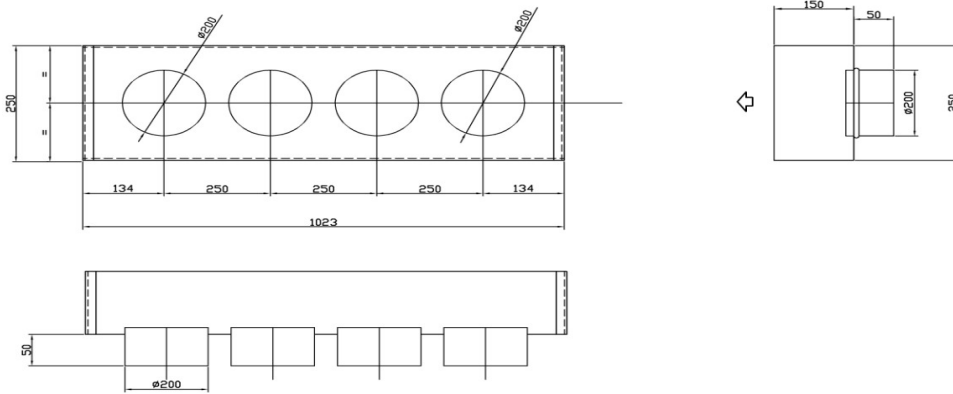

Retourframe (incl. filter) RFF25-45

TOEBEHOREN / ACCESSOIRES

Cadre reprise air avec filtre RFF25-45

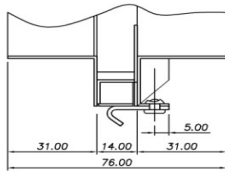
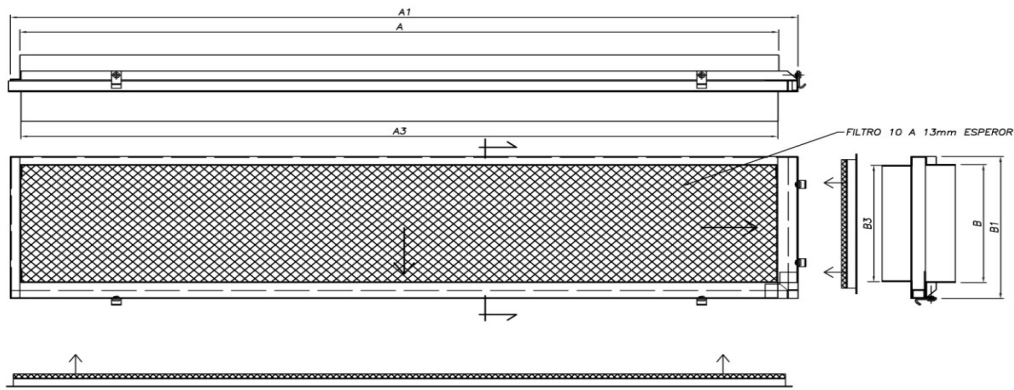

MODELO	FILTRO	A	A1	A3	B	B1	B3
AR-25-45	1027x249	1018	1045	1015	243	270	240

Technische fiche 6/6

Inbouw

GENERAL
AR45RIX / AON45RIX

6/6 Fiche technique

Encastrable

Flen inblaas rechthoekig UTD-SF045T

TOEBEHOREN / ACCESSOIRES

Bride de raccordement rectangulaire UTD-SF045T

40 mm

