





Binnenunit	Type	ARC14RIX			Type	Unité intérieure
Koelmiddel	Fabriekscode	ARXG14KSLAP			Code de fabrication	Réfrigérant
Verwarming (*)	Vermogen	kW	5,6	kW	Puissance	Chauffage (*)
Koeling (*)	Vermogen	kW	5,0	kW	Puissance	Refroid. (*)
Binnendeel	Debiet Q/L/M/H	m ³ /h	360/530/640/800	m ³ /h	Débit Q/L/M/H	Unité intérieure
	Geluidsdruk Q/L/M/H (1m)	dB(A)	23/27/30/35	dB(A)	Niv. son. press. Q/L/M/H (1m)	
	Werkgebied ext. stat. druk	Pa	0-30	Pa	Plage de fonct. press. stat. ext.	
	Ext. stat. druk fabrieksinst.	Pa	10	Pa	Réglage d'usine press. stat. ext.	
	Werkingslim. verwarmen	°C	16~30	°C	Plage de fonct. chauff.	
	Werkingslim. koelen	°C	18~30	°C	Plage de fonct. refroid.	
	Hoogte-breedte-lengte	mm	198-700-450	mm	Hauteur/largeur/profond.	
Inbouwhoogte	mm	225	mm	Hauteur encastrable		
Gewicht	kg	15,5	kg	Poids		
Tech.install.	Expansie		Ext.		Détente	Install. Techn.
	Koelleidingen	inch	3/8 -1/4	inch	Lignes frigorifique	
	Sectie tssn bi en bu	mm ²	4G1.5	mm ²	Section entre int. et ext.	
	Diam. condensafvoer	mm	25/32	mm	Diam. évac. Condensat	

(*) gegevens volgens de norm EN14511

(*) suivant la norme EN14511

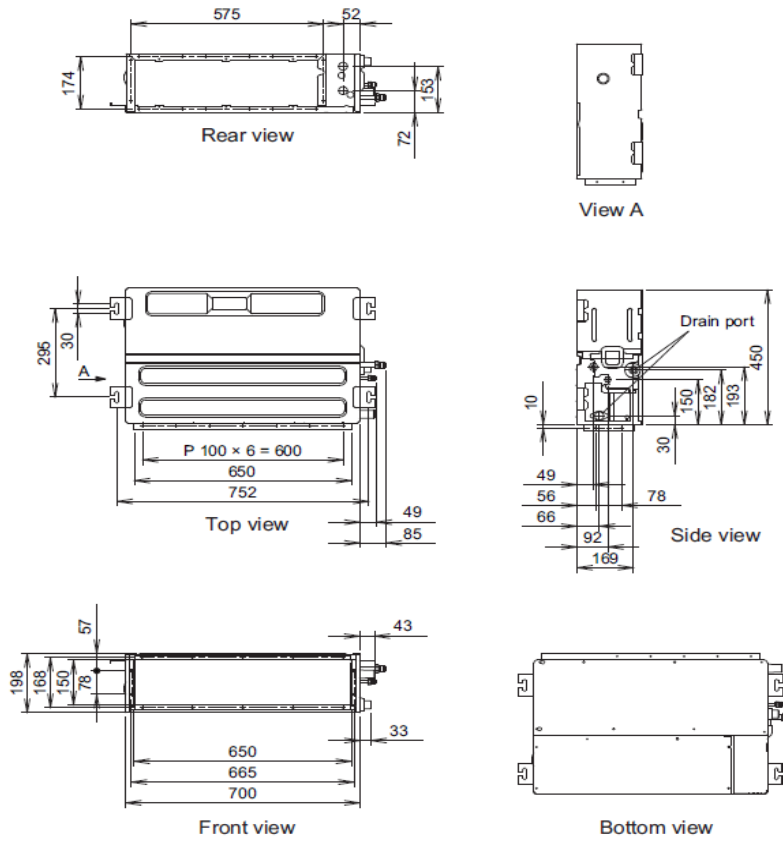
Unit: mm



Montage

Montage

Provide sufficient installation space for product safety.

Unit: mm

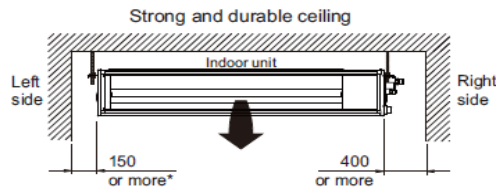

*: 400 or more when drain from drain pipe

• When intaking air from back:

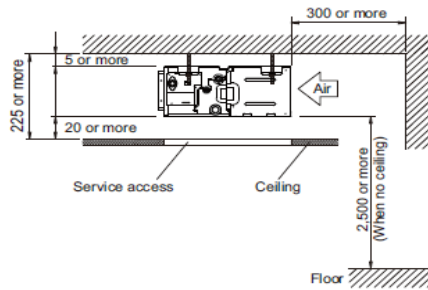

• When intaking air from bottom:

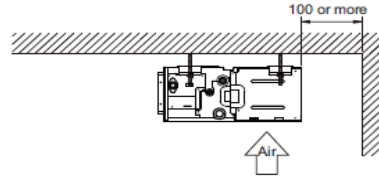

Inblaasplenum IBPL7-14

TOEBEHOREN/ACCESSOIRES

Plénum de pulsion IBPL7-14

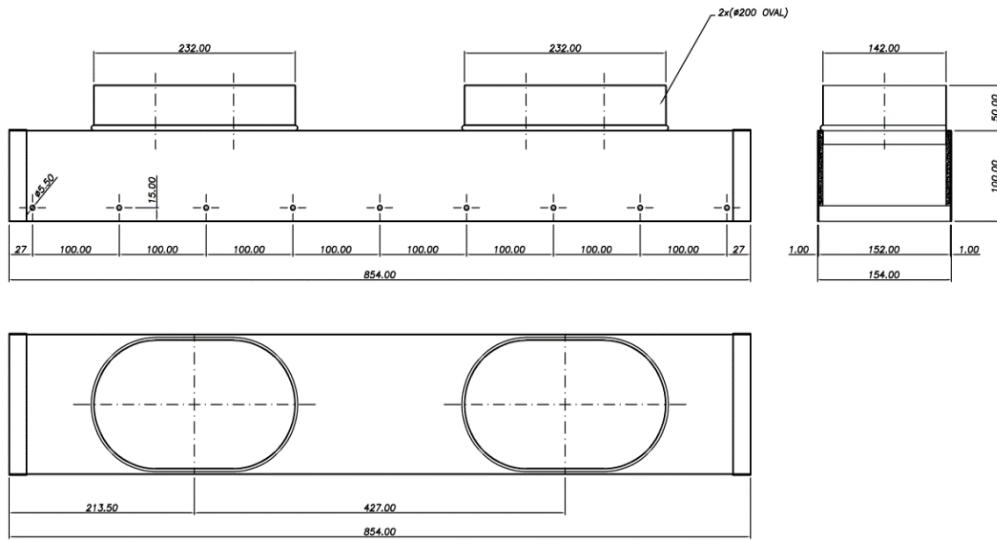

Retourplenum RP7-14

Plénum de retour RP7-14

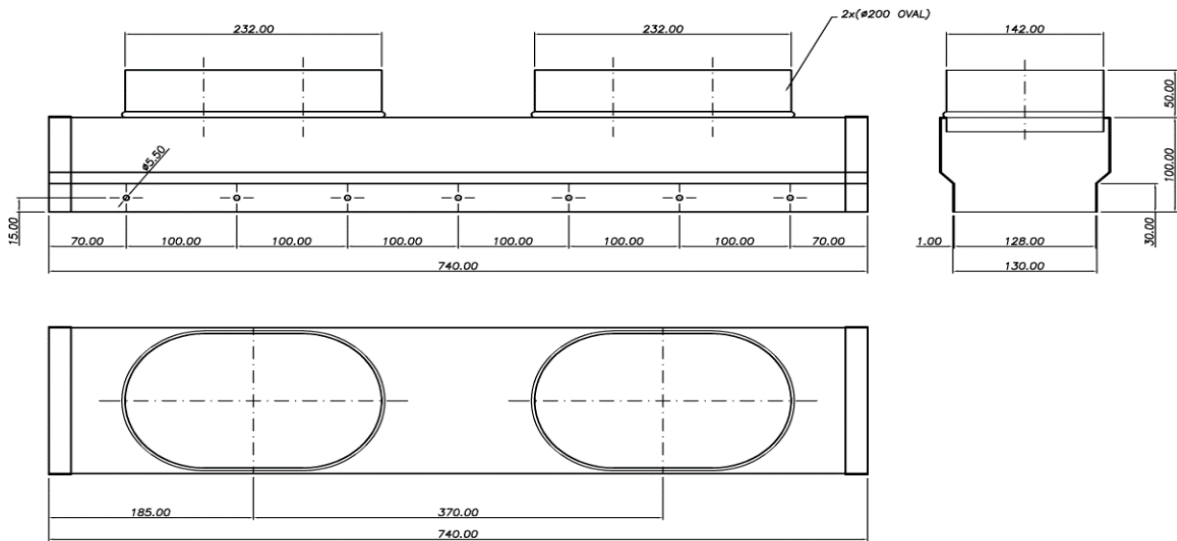

ARC14RIX

Retourframe (incl. filter) RFF7-14

Cadre reprise air avec filtre RFF7-14

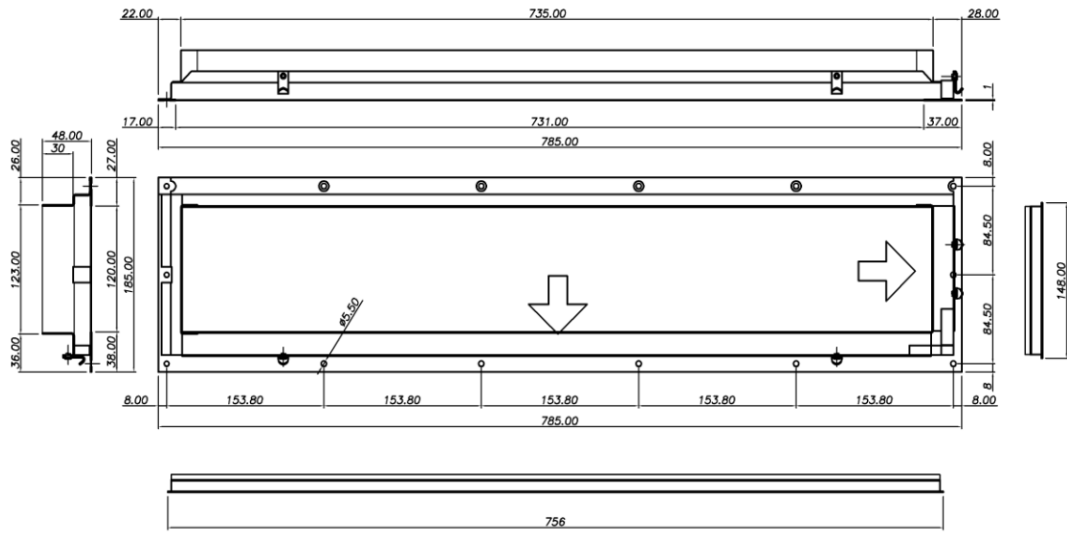

Adaptieplaat APR7-14

Placque d'adaption APR7-14

